



woodfire
21st century heating



The stove pictured on the cover is the Evo 30 (see page 7)

Printed using vegetable inks on FSC certified paper. Please recycle after use.

www.woodfirestoves.co.uk

Woodfire Technical range

Contents

The Woodfire Technical range	2
● Woodfire CX freestanding boiler stoves	3
● Woodfire RX inset boiler stoves	4
● Woodfire RX Panorama inset boiler stoves	5
● Woodfire RX double sided inset boiler stoves	6
● Woodfire Evo inset boiler stoves	7
● Woodfire Evo LD inset boiler stoves.....	8
● Woodfire RH inset stoves	9
● Woodfire RH LD inset stoves.....	10
● Woodfire RH double sided inset stoves	11
Sustainable fuel	12
Chimney	13
Installation chamber.....	14
Thermal storage	15
Woodfire frames.....	15
System controller	15
Dimensions.....	16



A red droplet indicates that the stove is a boiler stove



RH 14

The Woodfire Technical range

Woodfire woodburning stoves use the latest combustion technology to achieve very high efficiencies and low emissions. The Woodfire Technical range of dedicated wood burners includes both freestanding and inset models, either with or without a boiler. Both single and double sided models are available and they can have side-opening or counterbalanced up-and-down doors.

The boiler models are designed to run full central heating systems and supply domestic hot water, and can range in output from 3kW to 40kW. All of them can be installed in open vented or pressurised systems, have direct air, and can link with existing conventional boilers.

The dry stoves share the same excellent build quality and accurate control of the burning rate and are known for their high efficiency, controllability and panoramic windows.

All Woodfire stoves carry a five-year warranty except for the freestanding stoves which have a 24-month warranty.



CX 12

● Woodfire CX freestanding boiler stoves



These freestanding models have a high heat output to water and a low output to the room, making them perfect for a well-insulated, modern house. They can have 100% direct air and can be installed into a pressurised or open vented system. Having primary, secondary and tertiary combustion air makes them highly efficient and very clean burning.



CXT 12



CXC 12

Models in this range

CXT 12 2-11kW

CX 12 2-11kW

CXC 12 2-11kW



RX 20

● Woodfire RX inset boiler stoves



The Woodfire RX stoves, with a choice of nine different models, represent the widest choice of high-efficiency boiler stoves on the market today. With a three-sided firebox boiler as well as heat exchanger tubes above, they capture all the available heat and can pass it into a thermal store or directly into the heating circuit. All the models are firebrick-lined to ensure a high firebox temperature and thus a clean and efficient burn. Every stove has a flue draught damper to prevent over-drawing, and so maximise efficiency whatever the chimney height, and full control over primary and secondary air to allow slow burning.



RX 30

Models in this range	
RX 12	3–12kW
RX 15	3–15kW
RX 20	4–20kW
RX 25	5–25kW
RX 30	6–30kW



RX 30 Panorama

● Woodfire RX Panorama inset boiler stoves



The two RX Panorama models have the same high efficiency and big output to water as the rest of the RX range but give an even better view of the fire, with a door over a metre wide. This also gives you a wider firebox, allowing you to fit in both longer logs as well as more fuel at a single loading.



RX 40 Panorama

Models in this range

RX 30 Panorama 6–30kW

RX 40 Panorama 8–40kW



RX 30 DS

● Woodfire RX double sided inset boiler stoves



A double sided stove adds a whole new dimension to any house. Built into the party wall, inset double sided fires take the minimum of space and yet the boiler models are still capable of running the full central heating system and the domestic hot water as well as directly warming both rooms. Unlike a freestanding stove, a double sided inset stove gives that cosy feel to both rooms without necessitating the big opening between them that a freestanding double sided stove requires.



RX 20 DS

Models in this range

RX 20 DS	5–20kW
RX 30 DS	6–30kW
RX 30 DS Panorama	6–30kW



Evo 30

● Woodfire Evo inset boiler stoves



The Evo models represent both the latest look in inset stoves, with frameless all-glass doors, and the latest in clean burning technology, with fully controllable primary, secondary and tertiary air feeds to the fire. 100% direct air taken from the outside, vermiculite firebox linings and efficiencies in excess of 80% all contribute to the Evos giving the most heat from the least wood.



Evo 20

Woodfire Evo stoves feature double glazed windows as standard which reduces the heat to the room, increases the heat to water and improves the airwash. All the Evo models come with an adjustable stand.

Models in this range

Evo 20	4–20kW
Evo 30	5–30kW
Evo 30 Panorama	5–30kW



Evo 30 LD Panorama

● Woodfire Evo LD inset boiler stoves



The Evo LD range, with their counterbalanced vertical lift doors, give the most contemporary look and are the easiest to use of all of the Woodfire Technical range. At the touch of a hand the door slides up to give a wide, easy loading facility and drops smoothly back down to seal the stove when you've finished putting in the logs.



Evo 20 LD

If you fancy having an open fire for a while, simply let the door slide up and out of sight.

Models in this range

Evo 20 LD	4–20kW
Evo 30 LD	5–30kW
Evo 30 LD Panorama	5–30kW



RH 17

● Woodfire RH inset stoves

These beautifully designed stoves can be installed higher up in the wall to create a very contemporary look or can be positioned within a fire surround to give the best of both worlds – the feel of a traditional fireplace but without the draughts and loss of heat associated with an open fire.



RH 14

Utilising primary, secondary and tertiary air to the firebox, RH inset stoves burn the wood cleanly and efficiently, and the resulting warmth can be ducted to other rooms or right around the house.

Models in this range

RH 14	3–14kW
RH 17	4–17kW
RH 21 Panorama	5–21kW



RH 21 LD Panorama

● Woodfire RH LD inset stoves

The vertical lifting door range gives the very best in woodburning inset stoves. RH lifting-door stoves have generously sized fireboxes, huge windows to see the flames through, a controllable, clean burning fire that has wonderful flame patterns – and all accessed through a counterbalanced up-and-down door. If you need to heat a large room or hall then the impressive RH 21 LD Panorama Ultra XL boasts a 1760mm wide door. Should you feel like sitting by an open fire then simply slide the door up and out of the way. The warmth can circulate through the room and around the

house or some of it can be ducted directly to other areas of the home.



RH 21 LD Panorama Ultra

Models in this range

RH 17 LD	4–17kW
RH 21 LD Panorama	5–21kW
RH 21 LD Panorama Ultra	5–21kW
RH 21 LD Panorama Ultra XL	5–21kW



RH 21 DS Panorama

● Woodfire RH double sided inset stoves

An RH double sided inset stove is a great way to make two rooms warm and snug with one fire or to create a wonderful central feature for a large room. An RH 21 DS Panorama gives a superb wide view of the fire and can be loaded with wood from either side. By using adjustable vents, the amount of heat going into each room can be controlled, depending on whether one or both rooms are in use, and warmth can also be ducted upstairs.



RH 17 DS

Models in this range

RH 14 DS	4–14kW
RH 17 DS	5–17kW
RH 21 DS Panorama	6–21kW



Sustainable fuel

Heating our homes and businesses accounts for around half of the UK's energy use and half of all our carbon emissions. With the threat of global warming, it is important that we start to move away from fossil fuels and towards a more environmentally friendly and sustainable energy. Wood is a local, renewable fuel that, when harvested from a sustainable source, is largely carbon neutral.

Through photosynthesis, trees convert light into chemical energy and absorb CO₂ and water to convert that energy into carbohydrates, which they then use to grow. When the tree is cut down and burned, the energy that was captured from the sun is released and heats your home. The CO₂ that goes back into the atmosphere from combustion is then reabsorbed by the tree that is growing in its place.

With modern, highly efficient stoves it is very important that the wood burned is properly dry. To get a clean burn, and the maximum heat from your stove, the wood needs to have been stored long enough for the moisture content to have dropped to no more than 25%.

Chimney

The correct chimney is a vital part of any stove installation. Woodfire stoves work at high efficiency levels, which means that little heat is lost up the chimney. For this reason the chimney needs to be well insulated to keep the flue gases flowing well and to reduce condensation of tar and water in the chimney.

A new chimney should be made from pumice or prefabricated insulated stainless steel chimney sections. Pumice forms a highly insulating masonry chimney. Non-structural timbers and combustible materials can be run right up to a pumice chimney (which also makes it simple to achieve an airtight junction with the building). A pumice chimney can withstand higher temperatures and so is more resilient.

Twin-wall stainless chimney is well suited to existing houses, as it is easy to retrofit but can also be used for new-build projects. Existing masonry chimneys should be lined with a flexible liner that is then insulated to keep the flue gases warm.

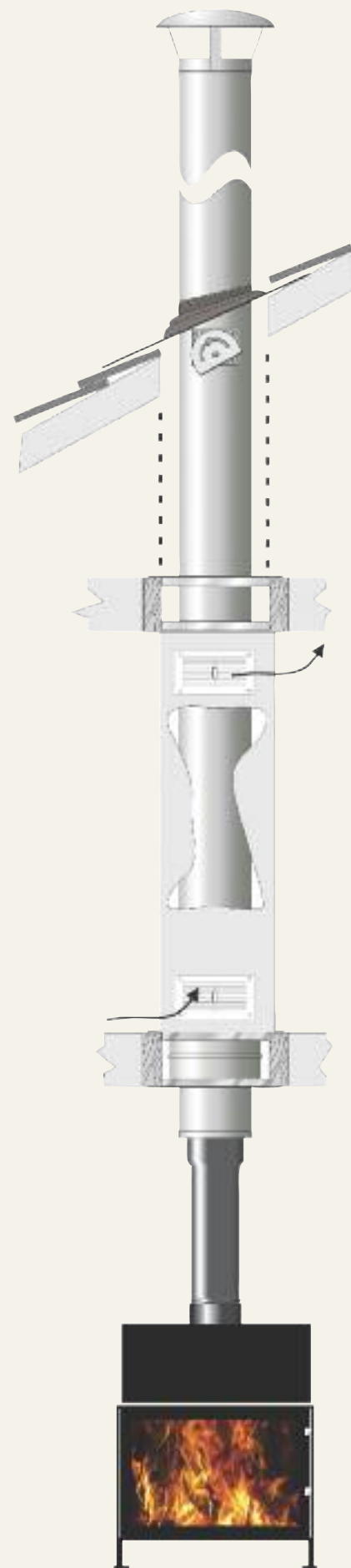
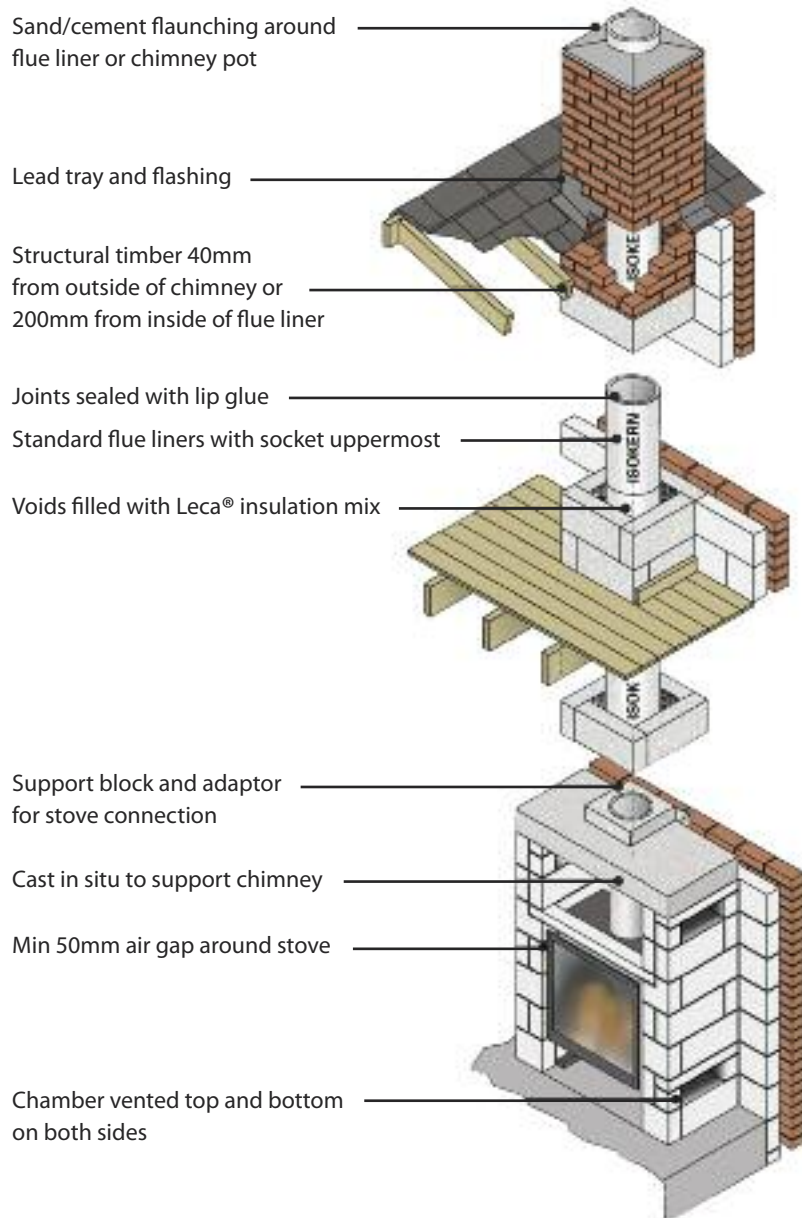



Installation chamber

Woodfire inset models are installed into a chamber with an air gap around the stove. You can use an existing fireplace opening or create an entirely new chamber with Thermalux boards. Thermalux is fireproof, highly insulating and structural, making it quick and easy to construct the installation chamber for an inset stove.

Vents are positioned below the stove, or on the sides of the chimney breast at the bottom, and others are placed near the top of the chamber. The natural convection will draw cool air from the floor area, warm it around the stove and then circulate it around the room. This may be done from the chamber or, by utilising the optional convection casing, warmth can be ducted directly from the stove to other rooms in the house.

Woodfire inset stoves give out both radiant heat from the door and convected warmth from the stove body.

Convected heat gives a much more even warmth across the room, enabling you to sit around the stove without getting too hot, and spreads much further than radiant heat.

Thermal storage

A Woodfire boiler stove can be installed in an open vented or pressurised system and can power the heating and hot water needs of a whole house. They give around 80% of their heat to water and a mixture of radiant and convected warmth to the room. They can also be linked in with a conventional boiler and solar panels.

As with all high-output boiler stoves, Woodfires work at their very best when linked to a thermal store. This highly insulated tank will store the energy from the stove, letting you use it when needed. A typical cycle is to run the stove in the evening, warming the house and putting its excess heat into the store, then use that stored heat to give hot water and warm the house the next morning. The remaining heat will warm the house in the afternoon before you return from work and the stove is lit again.



Woodfire frames

Four-sided frames are available for all the inset models in the Woodfire Technical range. Once the stove has been installed, and the wall around it plastered, the frame is then added to make a neat finish between the stove and the surrounding wall.

Frames are available in matt black with a 50mm border.



System controller

The system controller regulates the burning rate of the stove, turning it down if it is getting too hot, or up if it has started to cool.

If you have a boiler stove then it will manage when the pumps turn on and when and where the heat goes – either to your central heating, your hot-water cylinder or to the thermal store. If there is a power cut then it can safely turn your boiler stove down. If you have a thermal store then it shows how hot your store is, which tells you if you need to add more fuel to the fire.

A control panel lets you set the temperatures you want and gives you a visual display of how your system is performing.

The system gives you the reassurance that, having loaded the stove, it will continue to perform safely and efficiently, even if your attention is elsewhere.



Dimensions

Stove	Output range (kW)	kW		Efficiency	Body (mm)			Door (mm)		Flue diameter
		Air	Water		H	W	D	W	H	
● CXT 12	2-11	1.8	9	82%	870	520	440	280	390	150
● CX 12	2-11	1.8	9	82%	870	520	450	280	390	150
● CXC 12	2-11	1.8	9	82%	1090	520	450	280	390	150
● RX 12	3-12	3	9	79%	645	680	485	640	460	150
● RX 15	3-15	4	11	80%	860	620	535	580	460	150
● RX 20	4-20	5.5	14.5	80%	860	680	535	640	460	200
● RX 25	5-25	6	19	80%	960	710	535	670	510	200
● RX 30	6-30	7	23	80%	960	800	535	760	510	200
● RX 30 Panorama	6-30	8	22	80%	960	1100	560	1060	510	200
● RX 40 Panorama	8-40	10	30	80%	960	1100	560	1060	510	250
● RX 20 DS	5-20	8	12	80%	860	680	595	580	460	200
● RX 30 DS	6-30	12	18	80%	960	800	595	760	510	200
● RX 30 DS Panorama	6-30	12	18	80%	960	1100	595	1060	510	200
● Evo 20	4-20	5	15	>80%	1088	680	555	640	465	200
● Evo 30	5-30	5	25	>80%	1088	800	555	760	465	200
● Evo 30 Panorama	5-30	5	25	>80%	1138	1100	555	1060	515	200
● Evo 20 LD	4-20	4	16	>80%	1090	809	607	640	465	200
● Evo 30 LD	5-30	6	24	>80%	1090	929	607	760	465	200
● Evo 30 LD Panorama	5-30	6	24	>80%	1140	1229	607	1060	515	200
● RH 14	3-14	14		>80%	1070	680	567	640	465	200
● RH 17	4-17	17		>80%	1070	800	571	760	465	200
● RH 21 Panorama	5-21	21		>80%	1170	1100	569	1080	515	200
● RH 17 LD	4-17	17		>80%	1270	926	595	760	465	200
● RH 21 LD Panorama	5-21	21		>80%	1370	1226	595	1080	515	200
● RH 21 LD Panorama Ultra	5-21	21		>80%	1470	1526	595	1360	565	200
● RH 21 LD Panorama Ultra XL	5-21	21		>80%	1449	1929	646	1760	565	300
● RH 14 DS	4-14	14		>80%	1120	680	610	640	465	200
● RH 17 DS	5-17	17		>80%	1120	800	611	760	465	200
● RH 21 DS Panorama	6-21	21		>80%	1165	1100	610	1060	515	200

All the Woodfire Technical range can have 100% direct air
All models come with firebrick linings

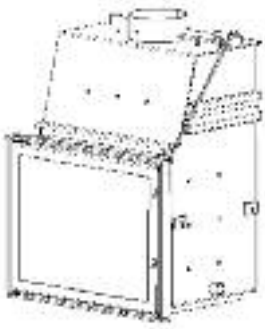

Woodfire RX

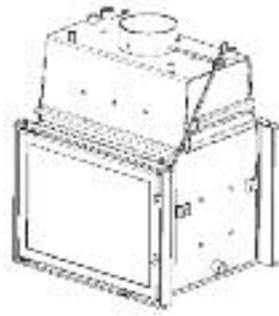

Woodfire RX DS

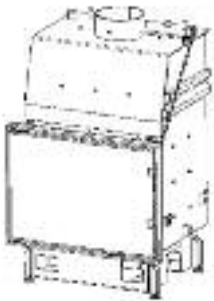

Woodfire Evo

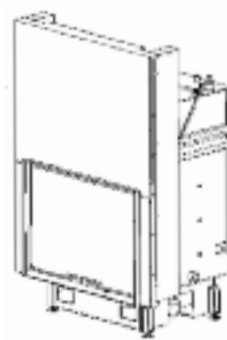

Woodfire Evo LD

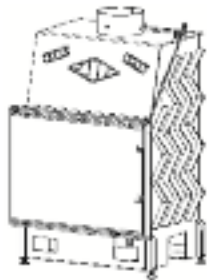

Woodfire RH

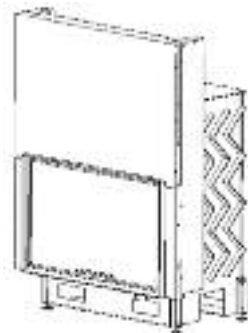

Woodfire RH LD

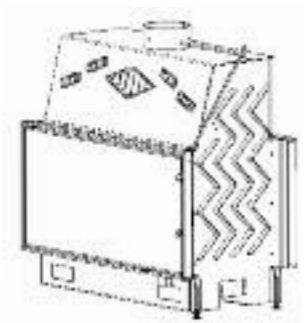

Woodfire RH DS

These line drawings illustrate the shape and construction of Woodfire Technical inset stoves.

Of course, once installed only the door and window are visible.



Unit 11/12 Quadrant Distribution Centre, Quedgeley, Gloucester, GL2 2RN

www.firepowerheating.co.uk sales@firepowerheating.co.uk 01803 712 735